

DATE: 2016-2-18 (YY/MM/DD)

Customer :

APPROVAL SHEET

PRODUCT: AC ADAPTOR

MODEL: GEO151UB-6025

PART NO. C688-13917

V : A1

Receiver's stamp or signature

PLEASE APPROVE & RETURN BEFORE 2016-2-21
OR WE WOULD REGARD IT BEEN CONFIRMED.

RESPONSIBLE	APPROVED	ISSUED

ISSUES STAMP

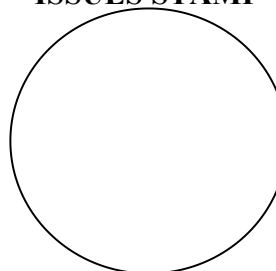

Revised History

NO.	Revised Date	Description	Approved	Issued
1	2016-6-22	DOE6.0		2016-6-29

GEO TECHNOLOGY CO., LTD.

D.3 Building, Tianyang,4Road Tianyang Industrial,East AvenueSonggang Town , Shenzhen,Guangdong,Chi

<http://www.szjiao.com>

TEL:(86-755)33925289 FAX:(86-755)33925289

E-mail: made555888@163.com sjl@88gme.com

	DESCRIPTION	SWITCHING POWER AC ADAPTER	SHEET NO.	1 OF 4
	MODEL NO.	GEO151UB-6025	VER:	A1
			PART NO.	C688-13917

1.INPUT REQUIREMENT

2.OUTPUT SPECIFICATION

3.MECHANICAL

4.RELIABILITY

5.ENVIRONMENT

6.OUTLOOKING

7.SAFETY

8.QC CHECK

9.DIMENSION

10.LABEL

11.PACKING

	DESCRIPTION	SWITCHING POWER AC ADAPTER	SHEET NO.	2 OF 4
	MODEL NO.	GE0151UB-6025	VER:	A1
			PART NO.	C688-13917

1.INPUT REQUIREMENT

ITEM	SPECIFICATION	MIN	TYP.	MAX
NORMAL AC INPUT VOLTAGE	SINGLE PHASE	100Vac	110Vac/220Vac	240Vac
AC INPUT VOLTAGE RANGE	SINGLE PHASE	90Vac	110Vac/220Vac	264Vac
AC INPUT FREQUENCY	SINGLE PHASE	47Hz	50/60Hz	63Hz
AC INPUT CURRENT	TYPICAL INPUT VOLTAGE& OUTPUT AT FULL LOAD.			350mA
AC INRUSH CURRENT	TYPICAL INPUT VOLTAGE& OUTPUT AT FULL LOAD , 25°C.			30A
EFFICIENCY	TYPICAL INPUT VOLTAGE& OUTPUT AT FULL LOAD	80.27%		

2.OUTPUT SPECIFICATION

ITEM	SPECIFICATION	MIN	TYP.	MAX
NORMAL DC OUTPUT VOLTAGE			5.25V	
DC OUTPUT VOLTAGE RANGE	±5%	4.80V		5.60V
LOAD CURRENT RANGE			2.4A	
PEAK LOAD CURRENT	TIME<60S			
RIPPLE	TYPICAL INPUT VOLTAGE , TYPICAL LOAD CURRENT , 25°C			200mV
HOLD-UP TIME	AT TYPICAL INPUT VOLTAGE AND FULL LOAD	10mS		
TURN-ON DELAY	TYPICAL INPUT VOLTAGE AND TUP LOAD CURRENT			3S
OVER CURRENT PROTECTION	AUTO RECOVERY			
SHORT CIRCUIT PROTECTRON	THE ADAPTER SHALL NOT DAMAGE BY SHORT THE DC OUTPUT TO GROUND			
OVER VOLTAGE PROTECTION				0.1W

*TEST MEASURES

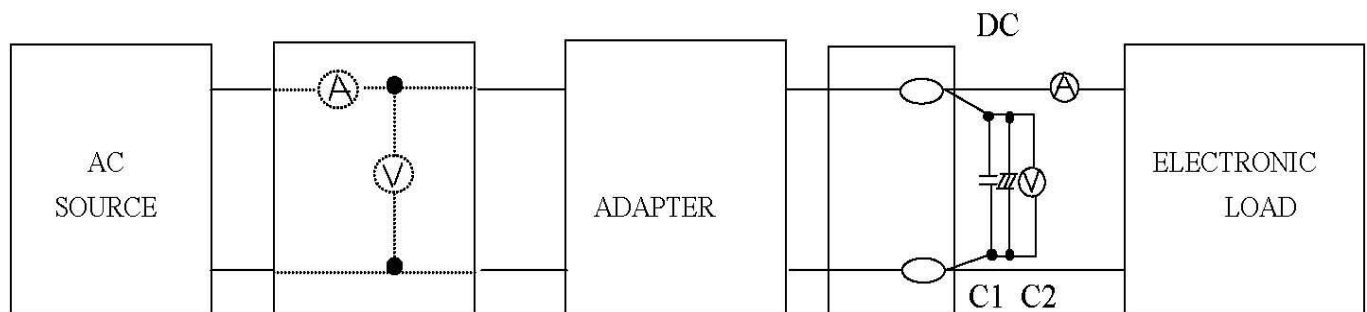

C1: 0.1uF CERAMICS CAPACITOR
C2: 10uF 50V ALUMINUM CAPACITOR

	DESCRIPTION	SWITCHING POWER AC ADAPTER	SHEET NO.	3 OF 4
	MODEL NO.	GE0151UB-6025	VER:	A1
			PART NO.	C688-13917

3.MECHANICAL

ITEM	SPECIFICATION OR TEST CONDITION	ACCEPTANCE CRITERIA
BENDING TEST	NORMAL TEMPERATURE THE CORD SHALL WITHSTAND WEIGHT OF 200g, SWINGING FROM LEFT TO RIGHT AT AN ANGLE OF 60 DEG. 1000CYCLE TIMES MIN. S/R SHALL WITHSTAND WEIGHT OF 1N. SWINGING FROM LEFT TO RIGHT AT AN ANGLE OF 60DEG. 1000CYCLE TIMES MIN. BENDING SPEED 40CYCLE/MINUTE	NO SHORT CIRCUIT NO BREAKAGE OF THE CORD
VIBRATION	FREQUENCY RANGE:10~55Hz AMPLITUDE:1.5mm ACCELERATION: 1G SWEEP 1 MINUTE FOR X,Y,Z.AXIS EACH	THERE SHALL BENO ABNORMALITY ON THE APPEARANCE STRUCTURE AND OPERATING

4.RELIABILITY

ITEM	TEST CONDITION	ACCEPTANCE CRITERIA
TEMPERATURE UP WITH	TEST AT SURFACE OF THE CASE WITH TYPICAL	TEMPERATURE UP UNDER
TYPICAL LOAD	AC INPUT AND TYPICAL LOAD IN OUTPUT	35 DEGREES
	50/60Hz	
HI-POT TEST	INPUT TO OUTPUT GRADUALLY RAISED FROM 0 TO THE 3000Vac AND HELD AT THAT VALUE FOR 3S,10mA	NO DAMAGE
INSULATION RESISTANCE	INPUT TO OUTPUT,DC 500V	>10MΩ
MTBF	TYPICAL INPUT&FULL LOAD , 25℃	50000 HOURS
BURN-IN	AT 30℃(±10℃),NORMAL INPUT VOLTAGE	2~4 HOURS

5.ENVIRONMENT

ITEM	SPECIFICATION OR TEST CONDITION	min.	typ.	max.
OPERATING TEMPERATURE		0℃		40℃
STORAGE TEMPERATURE		-20℃		85℃
OPERATING HUMIDITY	NON-CONDENSING	5%RH		90%RH
STORAGE HUMIDITY	NON-CONDENSING	5%RH		90%RH

	DESCRIPTION	SWITCHING POWER AC ADAPTER	SHEET NO.	4 OF 4
			VER:	A1
	MODEL NO.	GE0151UB-6025	PART NO.	C688-13917

6.OUTLOOKING

DIMENSION :59.5(L)X25.7(W)X79(H)mm
 WEIGHT :ABOUT g
 AC INPUT TYPE : WALL MOUNT
 DC OUTPUT TYPE :MICRO5PIN 类型

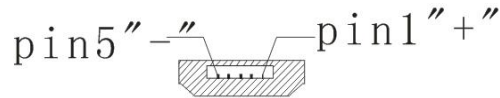

DC OUTPUT CABLE 2464 20AWG WIRE 线长1.8M
 INDICATION :LABEL
 CASE MATERIAL :94V-0 ABS+PC
 PCB MATERIAL :94V-0

7.SAFETY

COMPLY SAFETY STANDARDS	STANDARD	FILE NO.
UL CE		

EMI
FCC

8.QC CHECK

ALL OF THE QUANTITY SHALL BE CHECKED BEFORE SHIPMENT,CHECK ITEM AS BELOW:
 (1)DC PLUG POLE CHECK
 (2)OCP FUNCTION CHECK
 (3)DC OUTPUT VOLTAGE CHECK
 (4)HIPOT&INSULATION CHECK
 (5)OUTLOOKING CHECK

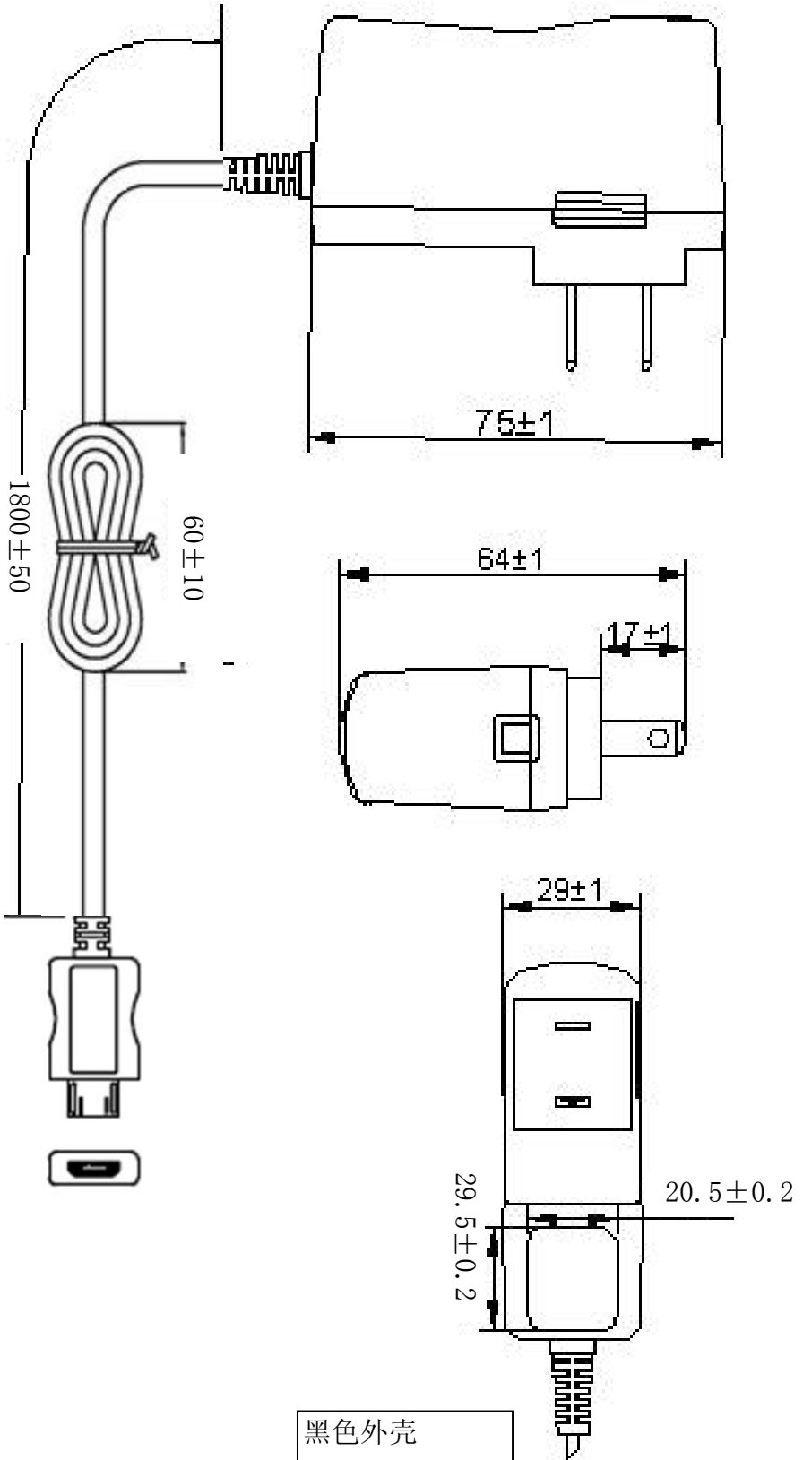

TOLERANCE		FINISH		MATERIAL		UNIT		NAME	
± 0.02	± 0.02	± 0.1	± 0.3	XXX	mm				
± 0.05	± 0.05	± 0.2	± 0.5	XXX	mm				
± 0.1	± 0.1	± 0.3	± 0.8	XXX	mm				
± 0.2	± 0.2	± 0.5	± 1.2	XXX	mm				
± 0.3	± 0.3	± 0.8	± 2.0	XXX	mm				
± 0.5	± 0.5	± 1.2	± 3.0	XXX	mm				
± 1.0	± 1.0	± 2.5	± 6.0	XXX	mm				
± 2.0	± 2.0	± 5.0	± 12.0	XXX	mm				
± 3.0	± 3.0	± 7.5	± 18.0	XXX	mm				
± 4.0	± 4.0	± 10.0	± 24.0	XXX	mm				
± 5.0	± 5.0	± 12.5	± 30.0	XXX	mm				
± 6.0	± 6.0	± 15.0	± 36.0	XXX	mm				
± 7.0	± 7.0	± 17.5	± 42.0	XXX	mm				
± 8.0	± 8.0	± 20.0	± 48.0	XXX	mm				
± 9.0	± 9.0	± 22.5	± 54.0	XXX	mm				
± 10.0	± 10.0	± 25.0	± 60.0	XXX	mm				
± 12.0	± 12.0	± 30.0	± 72.0	XXX	mm				
± 15.0	± 15.0	± 37.5	± 90.0	XXX	mm				
± 20.0	± 20.0	± 50.0	± 120.0	XXX	mm				
± 25.0	± 25.0	± 62.5	± 150.0	XXX	mm				
± 30.0	± 30.0	± 75.0	± 180.0	XXX	mm				
± 40.0	± 40.0	± 100.0	± 240.0	XXX	mm				
± 50.0	± 50.0	± 125.0	± 300.0	XXX	mm				
± 60.0	± 60.0	± 150.0	± 360.0	XXX	mm				
± 70.0	± 70.0	± 175.0	± 420.0	XXX	mm				
± 80.0	± 80.0	± 200.0	± 480.0	XXX	mm				
± 90.0	± 90.0	± 225.0	± 540.0	XXX	mm				
± 100.0	± 100.0	± 250.0	± 600.0	XXX	mm				
± 120.0	± 120.0	± 300.0	± 720.0	XXX	mm				
± 150.0	± 150.0	± 375.0	± 900.0	XXX	mm				
± 200.0	± 200.0	± 500.0	± 1200.0	XXX	mm				
± 250.0	± 250.0	± 625.0	± 1500.0	XXX	mm				
± 300.0	± 300.0	± 750.0	± 1800.0	XXX	mm				
± 400.0	± 400.0	± 1000.0	± 2400.0	XXX	mm				
± 500.0	± 500.0	± 1250.0	± 3000.0	XXX	mm				
± 600.0	± 600.0	± 1500.0	± 3600.0	XXX	mm				
± 700.0	± 700.0	± 1750.0	± 4200.0	XXX	mm				
± 800.0	± 800.0	± 2000.0	± 4800.0	XXX	mm				
± 900.0	± 900.0	± 2250.0	± 5400.0	XXX	mm				
± 1000.0	± 1000.0	± 2500.0	± 6000.0	XXX	mm				

jmh

SCALE

DWG NO.

XXX

PART NO.

C688-13917

DIMENSION

20.5 ± 0.2

C2

29.5 ± 0.2

**SWITCHING AC/DC
POWER ADAPTER**

MODEL:GEO151UB-6025
 I/P:100-240V ~ 50/60Hz 0.35A
 O/P:5.25V \equiv 2.4A

I.T.E. POWER SUPPLY GMA102311-EA-001



CE

 LISTED
 E339441
 3WH2

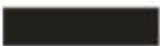





FC

MADE IN CHINA 

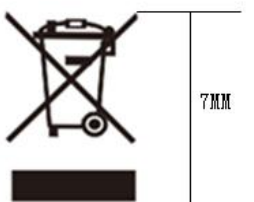
3-R1



NOTE:
 1.SILVER WORD ON BLACK BASE.
 2.MATERIAL:PVC +MYLAR FILM.

TOLERANCE					FINISH	XXXXXX			NAME	LABEL
L < 4	4 < L ≤ 20	20 < L ≤ 50	50 < L ≤ 200	200 < L		MATERIAL	XXX	REV.		
DEG.	CHKD.	APPD.		UNIT	mm					
			SCALE	REF.	XXXX			PART NO.	C688-13917	
				DWG NO.	XXXX					

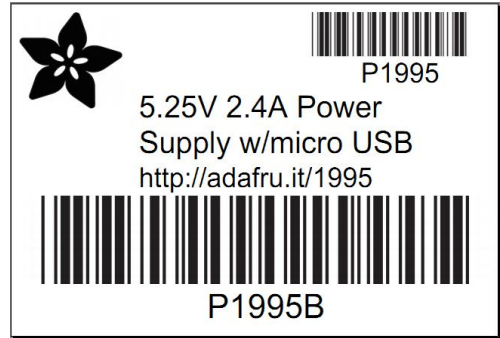
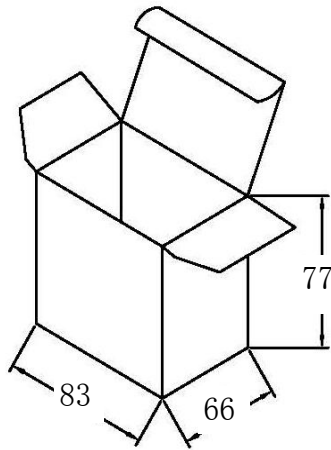

白盒标:
尺寸: 57*38mm,
材质: 白底不干胶

WHITE INNER BOX+OUT CARTON

WHITE INNER BOX OUT SIDE DIMENSION:

L×W×H(83*66*77)

TOLERANCE:±3

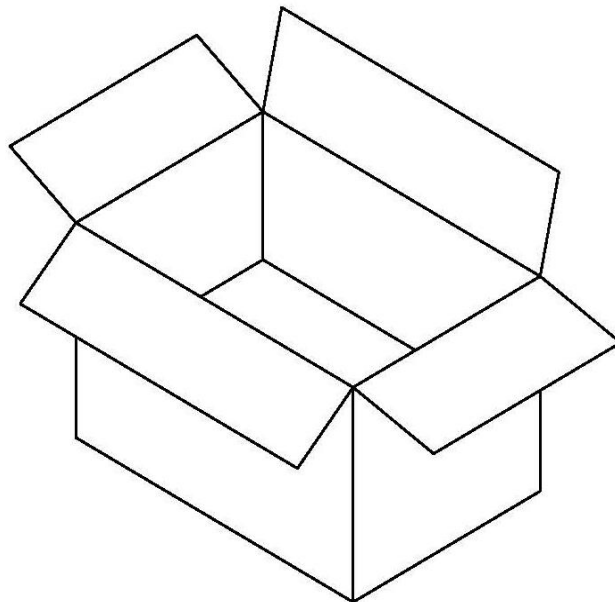

490*350*265 外销箱

TOLERANCE					FINISH			NAME	PACKING
L<4	4<L<20	20<L<50	50<L<200	200<L		REV.	A1		
±0.05	±0.08	±0.1	±0.2	±0.3	MATERIAL				
±0.1	±0.15	±0.3	±0.4	±0.6					
±0.2	±0.4	±0.5	±0.8						
DEG.	CHKD.	APPD.	UNIT	mm	SCALE	REF.	DWG NO.	PART NO.	C688-13917